

# CLB

## Coin Type Lithium-ion Rechargeable Battery

### Secondary Battery



## COIN TYPE LITHIUM-ION RECHARGEABLE BATTERY (CLB)

### Notes for Designers

Select the correct type of battery to match the operating conditions such as load current, etc.

#### ■ Charge conditions

To get the most out of coin type lithium-ion batteries and use them safely, please use specified charge IC, protection IC and read the following requirements carefully: For different charge IC, protection IC, consult your nearest Maxell dealer or distributor.

#### Charge conditions

Charge IC	Specified IC by Maxell
Charge method	Constant current, constant voltage charge
Charge voltage	4.20±0.05V / cell
Standard charge current	0.5I <sub>A</sub>
Max. charge current	1.0I <sub>A</sub>
Charge temperature	0 to +45 deg. C

#### Protection conditions

Protection IC	Specified IC by Maxell
---------------	------------------------

#### ■ Charge control flowchart (sample)

Refer to the following flowchart when designing constant current and constant voltage battery chargers.

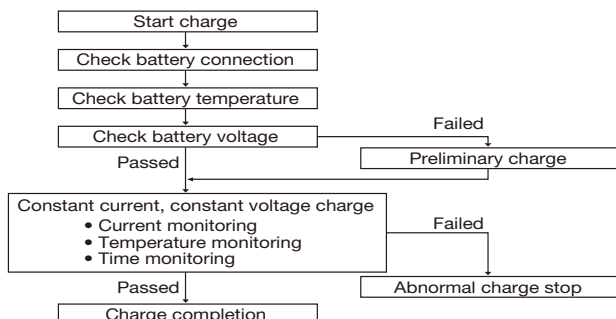

### Safety Instructions

The battery contains organic solvents and other combustible materials. For this reason, improper handling of the battery could lead to distortion, leakage\*, overheating, explosion or fire, causing bodily injury or equipment trouble. Please observe the following instructions to prevent accidents. The following are general cautions and guidelines only and as such may not include every possible usage scenario. The manufacturer will not be liable for actions taken

or accidents caused.

(\* Leakage is defined as the unintentional escape of a liquid from a battery.)

### ! Danger

- Do not dip or wet the battery in water, seawater, or other liquid. Otherwise the battery may be shorted, which may generate heat or cause damage.
- Do not put the battery into a fire. Otherwise, the electrolyte may burn or cause an explosion or fire.
- Do not heat the battery. Otherwise heating the battery could increase the internal pressure, causing leakage, explosion, overheating or fire.
- The battery has a predetermined polarity. If the battery will not connect well to the charger or equipment, do not try to connect the battery forcefully. Check the polarity first. If the battery is connected in reverse, it will be charged in reverse and may cause distortion, leakage, overheating, explosion or fire due to an abnormal chemical reaction during charge or an excessive current during discharge.
- Do not let the battery terminals (+ and -) come into contact with a wire or any metal (like a metal necklace or a hairpin) with which it is carried or stored. In such a case, the battery will be shorted and discharge excessive current, which may result in overheating, explosion, fire or heat generation of the metal necklace or the hairpin.
- Do not apply any heavy impact to the battery, throw or drop it. Do not apply heavy load to the battery causing distortion. Otherwise the battery may be shorted and result in leakage, overheating, explosion or fire.
- Do not drive a nail into, hammer or stamp on the battery. Otherwise the battery may be shorted and result in destruction, distortion, overheating, explosion or fire.
- Do not weld a terminal or weld a wire to the body of the battery directly. The heat of welding or soldering could cause damage to the insulating material or the structure in the battery, leading to distortion, leakage, overheating, explosion, or fire. When soldering the battery directly to equipment, use the battery with tabs or leads and solder only the tips of the tabs or leads. Do not use a soldering bath, because the circuit board with battery attached could stop moving or the battery could drop into the bath. Moreover do not use excessive solder, because the solder could flow to unwanted portions of the board, leading to a short-circuit or charging of the battery by connecting to power source.

# COIN TYPE LITHIUM-ION RECHARGEABLE BATTERY (CLB)

Please consult Maxell in advance for information about soldering conditions.

- Do not disassemble or alter the battery. Otherwise the insulating materials or the inside structure could be damaged, leading to distortion, leakage, overheating, explosion or fire.
- After long periods of storage without being used, the battery should be charged before it is used. Charge the battery every 6 months to the level specified by the manufacturer, even if the battery is not used. Otherwise over-discharging the battery may cause an abnormal chemical reaction in the battery and result in the degradation of battery performance, such as a shortening of battery life, distortion, leakage, overheating or fire.
- When charging the battery, always follow the charge conditions specified by the manufacturer. If the battery is charged under other conditions (a high temperature, a high voltage/current or an altered charger) not specified by the manufacturer, the battery may cause distortion, overheating, explosion or fire due to abnormal chemical reactions.
- Do not connect the battery directly to an electric outlet or cigarette lighter socket in a car. Applying a high voltage may generate an excessive current and cause an electric shock. In such a case, the battery may leak electrolyte, overheat, explode or cause fire.
- Do not use or leave the battery near fire, heaters, inside an automobile in hot weather or under strong sunshine. Such conditions of high temperature may damage the separator, and the battery may be shorted and result in overheating, explosion or fire.
- Do not use the battery with any equipment or device other than those specified by the manufacturer. Any such practice may expose your equipment or device to an abnormal current, which may result in distortion, overheating, explosion or fire.

## Warnings

- Do not swallow. Always keep the battery out of the reach of infants and young children to prevent it from being swallowed. If swallowed, consult a physician immediately. Swallowing may lead to burns, perforation of soft tissue, and death. Severe burns can occur within 2 hours of ingestion.
- Do not put the battery in a microwave oven or a pressure cooker. Sudden heat may damage the seal of the battery and may cause overheating, explosion or fire.
- Do not use the battery together with a primary battery such as a dry battery or other battery of a different capacity, type and/or brand. In such a case, over-discharge during use or over-charge during charging may occur and abnormal chemical reactions may cause heat generation, explosion or fire from the battery.
- Design your equipment so that the end user cannot replace the battery by mistake. If you are an equipment manufacturer and need to replace the battery, please use a new one of the same type and same model as the existing one. Because this is a rechargeable battery, its characteristics are completely different from other primary batteries (e.g. coin type lithium manganese dioxide batteries: CR) or other secondary batteries (e.g. lithium manganese dioxide rechargeable batteries: ML) even though their shapes are alike. If a different battery is installed in the circuit in place of a CLB battery, gas could be generated or the primary battery could be short-circuited by charging. This could lead to distortion, leakage, overheating, explosion or fire.
- If you notice any unusual odor, heat, discoloration, deformation or any other characteristic apart from what you are used to while using, charging or storing the battery, then take it out of the equipment or charger, and avoid using it. Using it in such state may result in overheating, explosion or fire.

- If the battery leaks or emits an unusual odor, remove it from the vicinity of any fire immediately. The electrolyte may catch fire, which may cause explosion or fire.
- Do not let leaked electrolyte come into contact with the eyes. In the event of such contact, flush the eyes with plenty of water immediately and consult a doctor. Otherwise prolonged contact may cause serious injury.
- When charge does not stop in an expected period of time, stop charging. Otherwise the battery may cause overheating, explosion or fire.

## Caution

- Use protection circuit in the application or a battery pack in order to prevent over-charge or over-discharge. Excess charge current or charge voltage may cause distortion, leakage, overheating, explosion or fire.
- Do not allow the battery electrodes to come in contact with your skin or fingers. Do not stick the battery on skin with adhesive tape or glue. Otherwise the moisture from your skin could cause a discharge of the battery, which could produce certain chemical substances causing you to receive chemical burns.
- Please be careful when installing the battery not to short-circuit it with metal portions of the equipment. Otherwise this could lead to distortion, leakage, overheating, explosion or fire.
- Keep the contact force at more than 2N for stable contact. Otherwise the battery voltage may be lower than intended value due to poor contact condition.
- Do not use or leave the battery in a hot and highly humid place such as under the direct rays of the sun or in a car in hot weather. It may cause distortion, leakage, overheating, explosion or fire.
- Do not leave the battery or battery pack being charged after charge is finished. Otherwise it may cause the degradation of battery performance, such as a shortening of battery life.
- When the battery is expected not to be used for a long time, take the battery out of the equipment or device and store it in a less humid area.
- Do not use the battery in other than the following temperature ranges:

Charge	0 deg. C to +45 deg. C
Discharge	-20 deg. C to +60 deg. C
Storage (less than 30 days)	-20 deg. C to +50 deg. C
Storage (less than 90 days)	-20 deg. C to +35 deg. C

## Warnings – Disposal

The battery may be regulated by national or local regulation. Please follow the instructions of proper regulation. As electric capacity is left in a discarded battery and it comes into contact with other metals, it could lead to distortion, leakage, overheating, or explosion, so make sure to cover the (+) and (-) terminals with friction tape or some other insulator before disposal.

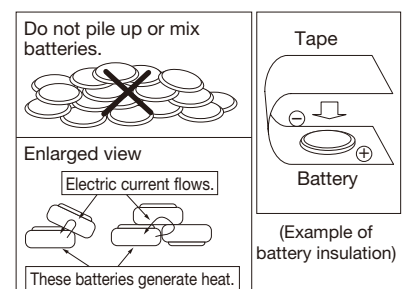

## Overview

Developed by Maxell, the coin type lithium-ion rechargeable battery has a high-rate discharge characteristic of up to 2I<sub>A</sub> by means of an original stacked electrode structure. This compact high-power rechargeable battery is designed for small portable devices such as IoT devices, wearables and hearables that have communication functions.

## Features

### High power

A unique stacked electrode structure enables power of up to 140mA (CLB2032).

### Discharge capability of CLB2032 is approximately 40 times better\*

\* Compared with Maxell's CR2032 at 60% available capacity

### Excellent cost performance

Superior recharging properties ensure a service life of about 500 charge/discharge cycles under normal usage conditions. The superior cost/performance ratio ensures that lithium-ion batteries are ultimately more economical than primary batteries.

### High reliability

Maxell has incorporated unique technologies gained during its development of crimping and electrode coating. The stainless steel battery body suppresses swelling.

### Superior safety

Separator-wrapped positive electrodes prevent to make internal short-circuit. Safety is ensured even if external short-circuit occurs.

## Certification

- UL 1642 Recognized models (Technician Replaceable): CLB2032, CLB2016, CLB937A, CLB740H  
Certification Number: MH12568
- IEC 62133-2 Recognized models: CLB2032, CLB937A, CLB740H
- UN 38.3 (Dangerous goods transportation regulations)  
Recognized models: CLB2032, CLB2016, CLB937A, CLB740H

## Applications

- Biological information monitoring systems
- Wearable data devices ● Medical sensor networks
- Environment monitoring systems
- Logistics management systems ● Rechargeable hearing aids
- Remote keyless entry systems (RKE) ● Multifunction watches

## Products

Model		CLB2032	CLB2016	CLB937A	CLB740H
Initial dimensions (mm) <sup>*1</sup>	Diameter	20	20	9.5	7.85
	Height <sup>*2</sup>	3.45	2.0	3.9	4.0
Weight (g) <sup>*1</sup>		3.0	2.1	0.7	0.5
Charge (CCCV)	Max. voltage (V)	4.2	4.2	4.2	4.2
	Standard current (mA)	35	15	9	9.5
	Temperature (deg. C)	0 to +45			
Discharge (CC)	End voltage (V)	3.0	3.0	3.0	3.0
	Max. current (mA)	140	60	36	19
	Temperature (deg. C)	-20 to +60			
Nominal voltage (V)		3.7	3.7	3.7	3.8
Nominal capacity (mAh) <sup>*3</sup>		70	30	18	19 <sup>*4</sup>

\*1 Dimensions and weight are for the battery itself, but may vary depending on terminal specifications and other factors.

\*2 100% charged

\*3 Nominal capacity is according to the following conditions: Charge: 0.5I<sub>A</sub>/4.2V (CCCV)/End current 0.03I<sub>A</sub>, Discharge: 0.2I<sub>A</sub>/E.V. = 3.0V, Temperature 20 deg. C

\*4 Nominal capacity is according to the following conditions: Charge: 0.5I<sub>A</sub>/4.2V (CCCV)/End current 0.03I<sub>A</sub>, Discharge: 1mA/E.V. = 3.0V, Temperature 20 deg. C

● Data and dimensions are just reference values. For further details, please contact your nearest Maxell dealer or distributor.

## Characteristics (CLB2032)

### Charge characteristics

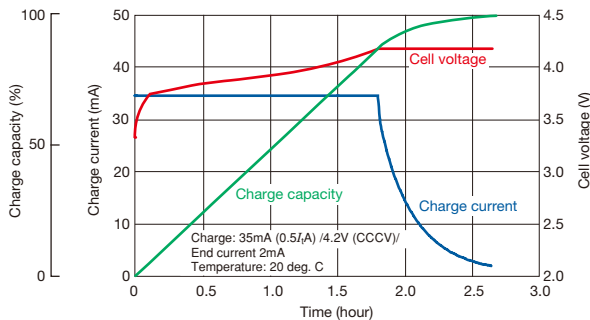

### Discharge temperature characteristics

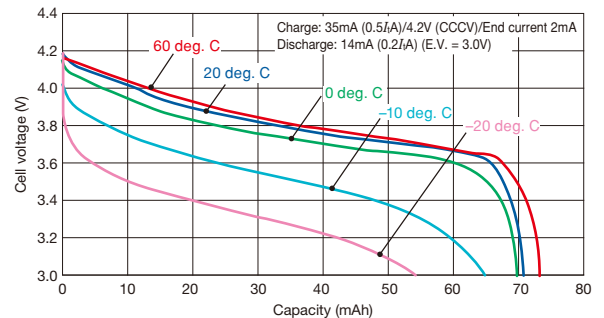

### Discharge load characteristics

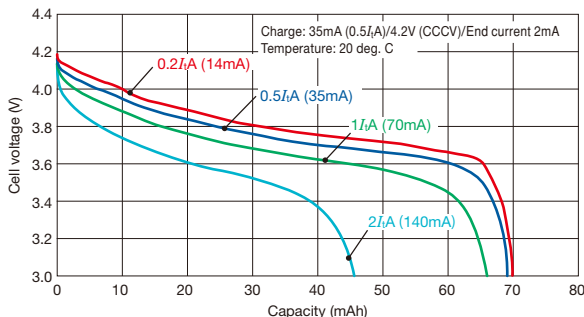

### Cycle life characteristics

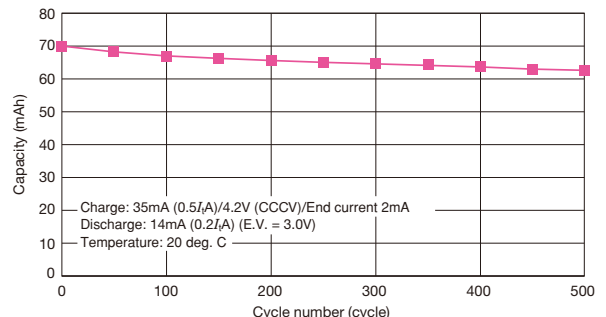

**Characteristics (CLB2016)**

**Charge characteristics**

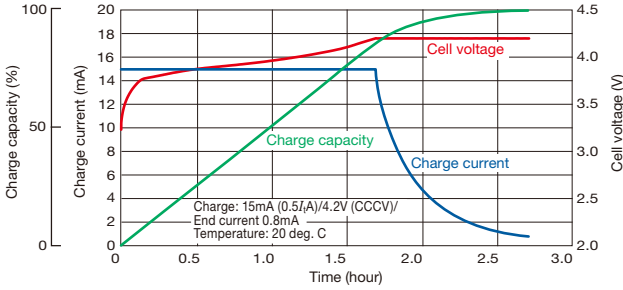

**Discharge temperature characteristics**

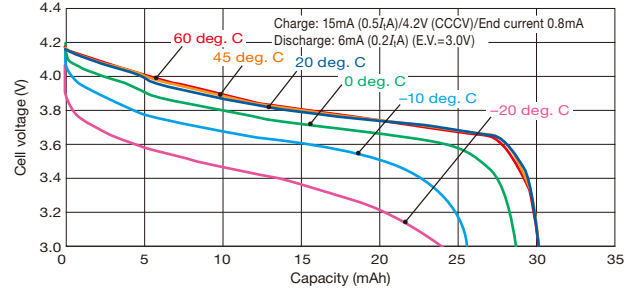

**Discharge load characteristics**

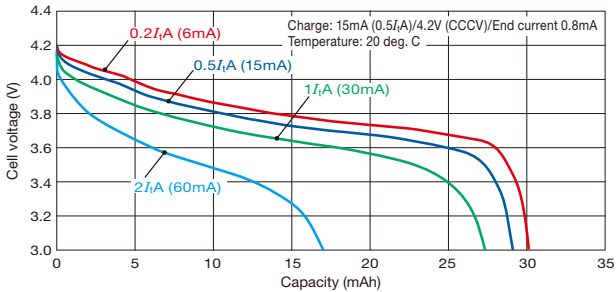

**Cycle life characteristics**

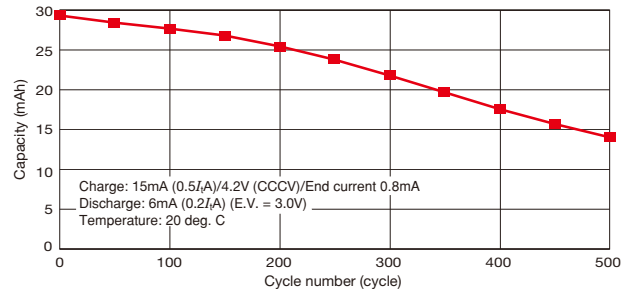

**Characteristics (CLB937A)**

**Charge characteristics**

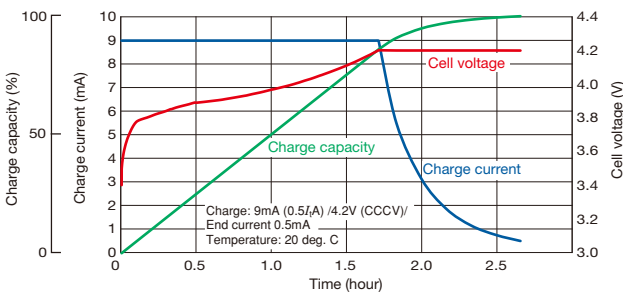

**Discharge temperature characteristics**

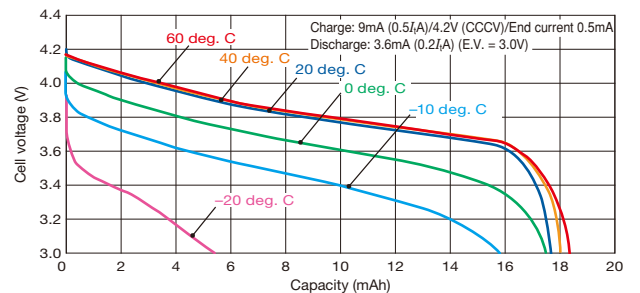

**Discharge load characteristics**

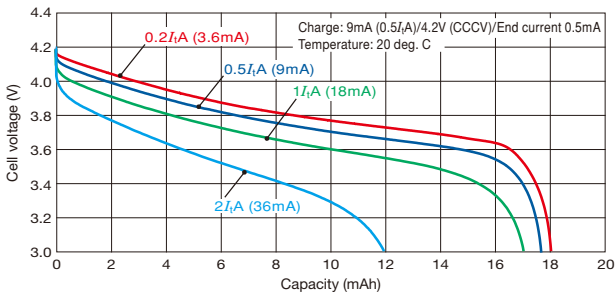

**Cycle life characteristics**

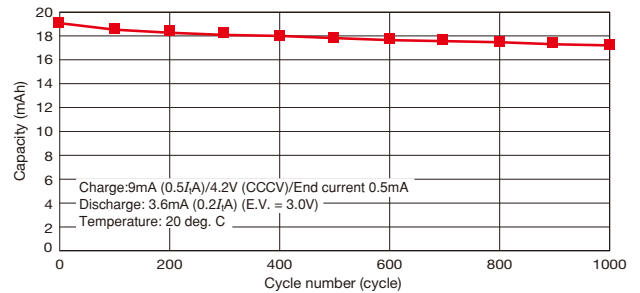

## Characteristics (CLB740H)

### Charge characteristics

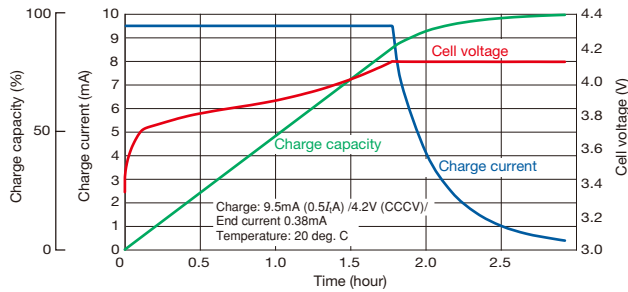

### Discharge temperature characteristics

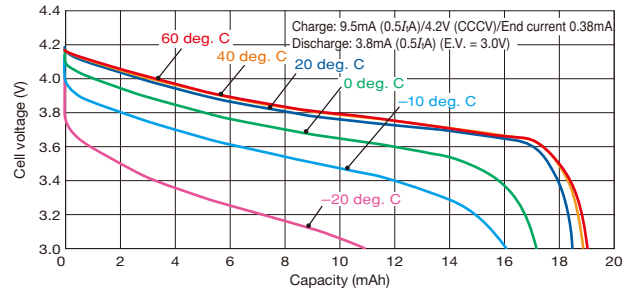

### Discharge load characteristics

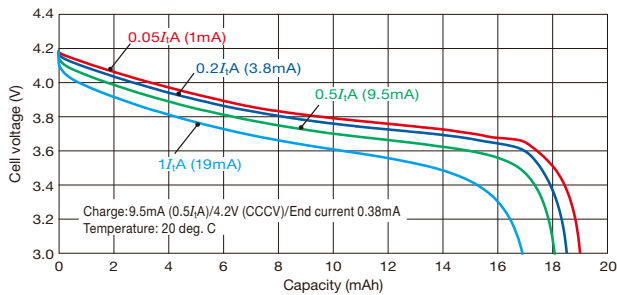

### Cycle life characteristics

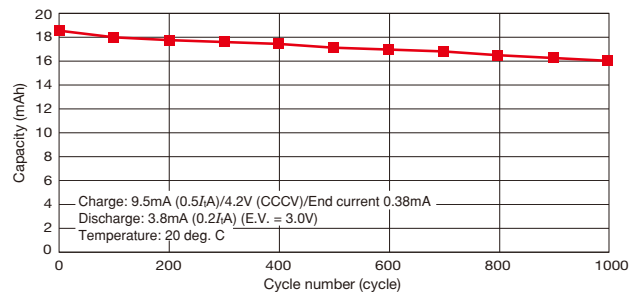

## External Dimensions with Terminals and Wire Connectors (unit : mm)

CLB2032 T1	CLB2032 WK1	CLB937A SBOS-T11
	<p>Housing: DF13-2S-1.25C (Hirose) Contact: DF13-2630SCF (Hirose) Lead wire: AWG28 UL1571</p>	

The above are examples. Processing to meet customer requests is possible.