

Silver Oxide Batteries

Data Sheet

SR44W

Model	SR44W
System	Zinc / Silver oxide
Nominal Voltage (V)	1.55
Nominal Capacity (mAh)*1	165
Nominal Discharge Current (μA)	200
Operating Temperature Range (deg. C)	-10 to +60
Dimensions (mm)	
Diameter	11.6
Height	5.4
Weight (g)	2.1

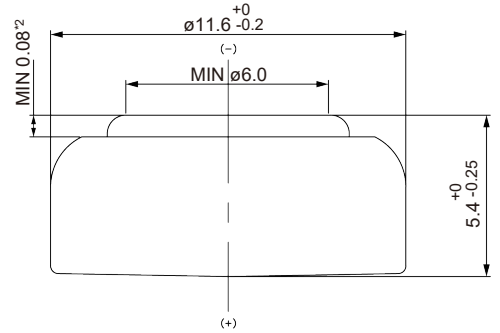

*2 The dimension is measured from the top surface of the negative can.

Characteristics

● Discharge Curve

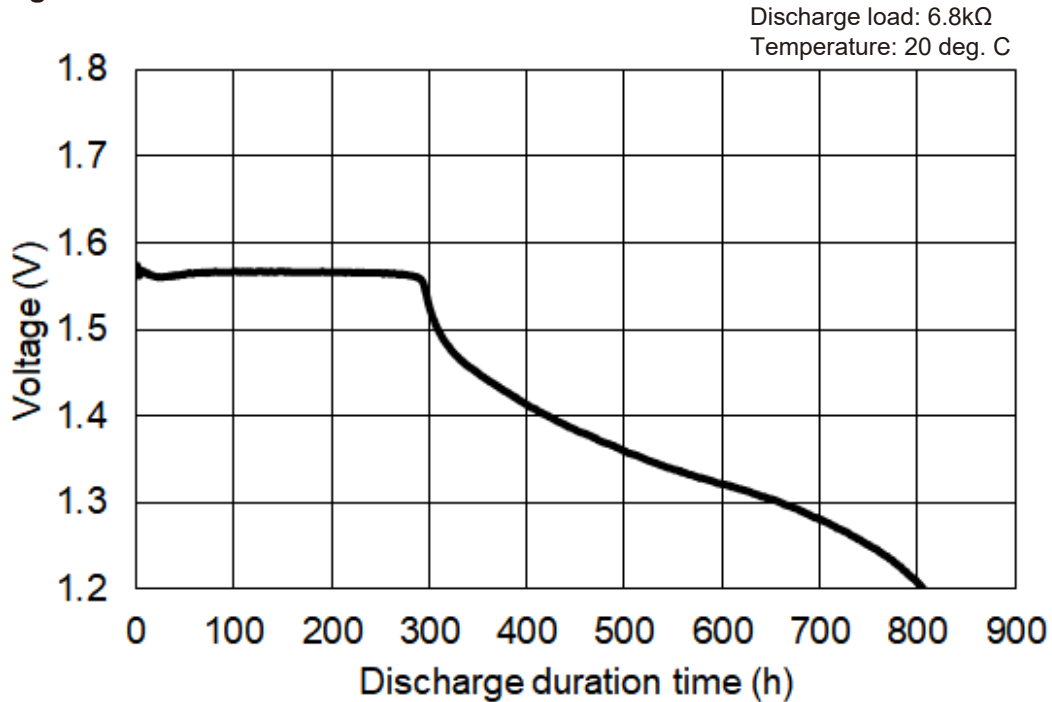

*1 Nominal capacity indicates the duration until the voltage drops to 1.2 V when discharged at a nominal discharge current at 20 deg. C.